

MOOG CONTROLLER
BDO-Q2-40-05
(940001)

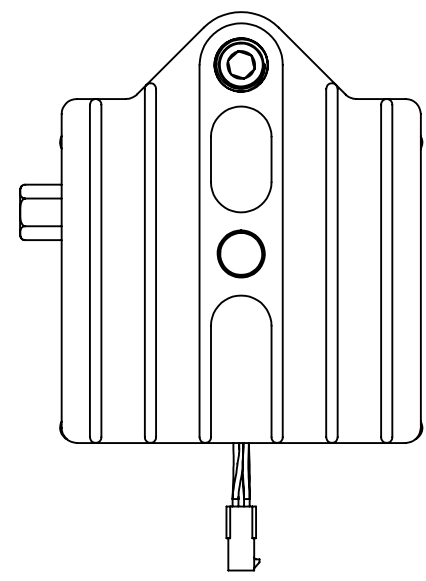

| WIRE COLOR | SIGNAL |
|------------|--------|
| YELLOW | Vcc |
| GRAY | Gnd |
| PURPLE | A coil |
| BLACK | B coil |
| GREEN | C coil |
| BROWN | S1 |
| WHITE | S3 |
| BLUE | S2 |

18 AWG WIRES

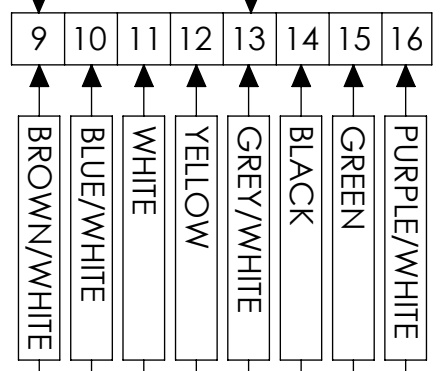
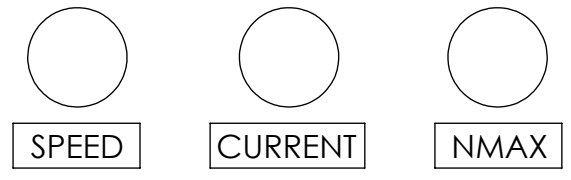
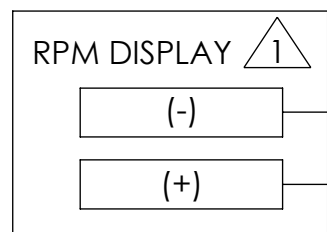
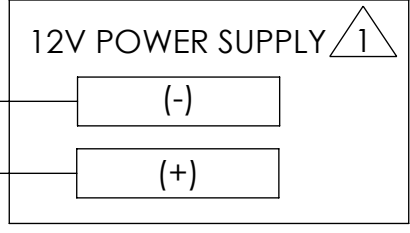
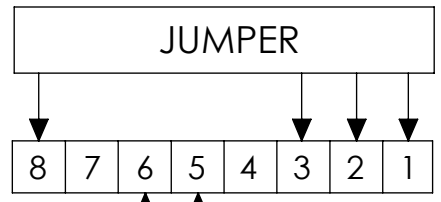
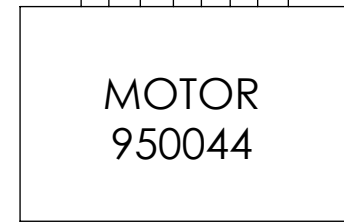

¹ NOT SUPPLIED BY AIR SQUARED. SHOWN FOR CUSTOMER USE.
2. BARE WIRE CONNECTIONS TYPICAL

CONFIDENTIAL.
THIS DOCUMENT AND
THE DATA DISCLOSED
HEREIN OR HERewith IS
NOT TO BE
REPRODUCED, USED, OR
DISCLOSED IN WHOLE
OR IN PART TO ANYONE
WITHOUT THE
PERMISSION OF AIR
SQUARED, INC.

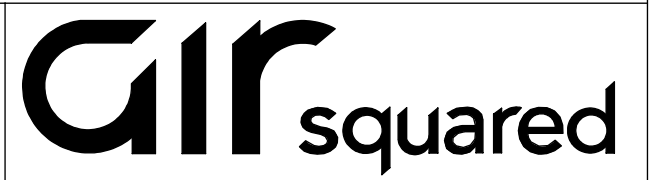

DESCRIPTION:
V10T016A-A01 SCROLL
COMPRESSOR - WIRING DIAGRAM

| | | | | |
|----------------------|------------|----------|--------------|------|
| DIMENSIONS ARE IN MM | | SIZE | PART NO. | REV. |
| SHEET 1 OF 1 | SCALE: 1:2 | B | V10T016A-A01 | 1 |